



FOGO MONTANHA





2022

- PT** Na Fogo Montanha todo o cuidado que colocamos nos nossos equipamentos parece-nos sempre pouco. O detalhe é o que nos distingue. Desfrute do nosso catálogo e sinta a qualidade dos nossos produtos. Perceba a razão de escolher Fogo Montanha.
- ES** En Fogo Montanha toda la atención que prestamos a nuestros equipos nos parece siempre poca. El detalle es lo que nos distingue. Disfrute de nuestro catálogo y sienta la calidad de nuestros productos. Entienda el motivo por el cual escoger Fogo Montanha.
- FR** Chez Fogo Montanha, le soin que nous apportons à nos équipements nous paraît toujours insuffisant. Le détail est ce qui nous distingue. Profitez de notre catalogue et appréciez la qualité de nos produits. Découvrez pourquoi vous devez choisir Fogo Montanha.
- EN** Fogo Montanha designs its units with exceptional care and a never ending attention to detail. Detail is our differentiator. We invite you to browse our catalogue and sense the quality of our products, Discover why you should choose Fogo Montanha.
- IT** Per noi di Fogo Montanha, l'attenzione che poniamo nella realizzazione dei camini non è mai abbastanza. È il dettaglio che ci distingue. Consultate il nostro catalogo e apprezzate la qualità dei nostri camini. Capirete l'importanza di scegliere Fogo Montanha.

ECODESIGN

- PT** Esta nova legislação, que entra em vigor a partir de 1 de Janeiro 2022, vai implicar novos equipamentos com elevados níveis de eficiência na queima e um baixo índice de emissões, o que os torna equipamentos verdadeiramente limpos, produzindo energia térmica de forma renovável. Estes novos equipamentos têm uma queima muito controlada e obrigam a requisitos mais restritos de instalação, para que operem com todo o seu potencial. Toda a gama Fogo-Montanha apresentada neste catálogo cumpre com os requisitos das novas normas Ecodesign.
- ES** Esta nueva legislación, que entra en vigor a partir del 1 de enero de 2022, exigirá nuevos equipos con altos niveles de eficiencia en la combustión y un bajo índice de emisiones, lo que los convierte en equipos realmente limpios, que producen energía térmica de forma renovable. Estos nuevos equipos tienen una combustión muy controlada y requieren unos requisitos de instalación más estrictos, para que funcionen con todo su potencial. Toda la gama de Fogo-Montanha presentada en este catálogo cumple con los requisitos de las nuevas normas de Ecodiseño.
- FR** Cette nouvelle législation, qui entrera en vigueur le 1er janvier 2022, exigera de nouveaux équipements présentant des niveaux élevés d'efficacité de combustion et un faible indice d'émissions, ce qui en fait des équipements véritablement propres, produisant de l'énergie thermique de manière renouvelable. Ces nouveaux équipements ont une combustion très contrôlée et nécessitent des exigences d'installation plus strictes, afin qu'ils fonctionnent au maximum de leur potentiel. L'ensemble de la gamme Fogo-Montanha présentée dans ce catalogue répond aux exigences des nouvelles normes Ecodesign.



EN This new legislation, which comes into force from 1 January 2022, will require new devices with high levels of efficiency in burning and a low index of emissions, which makes them truly clean devices, producing thermal energy in a renewable way. These new devices have a very controlled burning and require stricter installation requirements, so that they operate with their full potential. The whole Fogo-Montanha range presented in this catalogue fulfils the requirements of the new Ecodesign standards.

IT Questa nuova legislazione, che entra in vigore dal 1° gennaio 2022, richiederà nuove apparecchiature con alti livelli di efficienza nella combustione e un basso indice di emissioni, che le rende veramente pulite, producendo energia termica in modo rinnovabile. Queste nuove apparecchiature hanno una combustione molto controllata e richiedono requisiti di installazione più severi, in modo che funzionino con il loro pieno potenziale. Tutta la gamma Fogo-Montanha presentata in questo catalogo soddisfa i requisiti delle nuove norme di Ecodesign.

(*)	Wood	Pellets
NoX	<200 mg/m ³	<200 mg/m ³
OCG	<120 mg/m ³	<60 mg/m ³
Particle emissions	<40 mg/m ³	<20 mg/m ³
CO	<1500 mg/m ³	<300 mg/m ³
Performance	>65%	>79%

(*) Requisitos das novas normas EN 16510 / Requisitos de las nuevas normas de EN 16510 / Exigences des nouvelles normes de EN 16510 / Requirements of the new EN 16510 standards / Requisiti dei nuovi standard EN 16510



CERTIFICAÇÕES E QUALIDADE

Certificaciones y calidad / Certifications et qualité
Certifications and Quality / Certificazioni e qualità

- PT** Os nossos produtos destacam-se pela sua qualidade que começa na escolha das matérias-primas, passa por um rigoroso processo de produção e termina na garantia das certificações internacionais mais relevantes, garantindo a excelência. Os nossos clientes merecem o melhor.
- ES** Nuestros productos destacan por su calidad, que comienza con la elección de las materias primas, pasa por un riguroso proceso de producción y termina con la garantía de las certificaciones internacionales más relevantes, asegurando la excelencia. Nuestros clientes se merecen lo mejor.
- FR** Nos produits se distinguent par leur qualité, qui commence par le choix des matières premières, passe par un processus de production rigoureux et se termine par la garantie des certifications internationales les plus pertinentes, gage d'excellence. Nos clients méritent le meilleur.
- EN** Our products stand out for their quality, which begins with the choice of raw materials, goes through a rigorous production process and ends with the guarantee of the most relevant international certifications, ensuring excellence. Our customers deserve the best.
- IT** I nostri prodotti si distinguono per la loro qualità, che inizia con la scelta delle materie prime, passa attraverso un rigoroso processo di produzione e finisce con la garanzia delle più rilevanti certificazioni internazionali, assicurando l'eccellenza. I nostri clienti meritano il meglio.



Le label
du chauffage
au bois

- PT** Para além da qualidade, a inovação e o design está presente em toda a gama Fogo-Montanha, tendo recebido inclusive distinções a nível internacional como o Red Dot Design Award.
- ES** Además de la calidad, la innovación y el diseño están presentes en toda la gama de Fogo-Montanha, e incluso han recibido premios internacionales como el Red Dot Design Award.
- FR** Outre la qualité, l'innovation et le design sont présents dans toute la gamme Fogo-Montanha, qui a même reçu des prix internationaux tels que le Red Dot Design Award.
- EN** In addition to quality, innovation and design is present throughout the Fogo-Montanha range, and has even received international awards such as the Red Dot Design Award.
- IT** Oltre alla qualità, l'innovazione e il design sono presenti in tutta la gamma Fogo-Montanha, che ha anche ricevuto premi internazionali come il Red Dot Design Award.



reddot award 2017
winner



ICONOGRAFIA

Iconografia / Iconographie
Iconography / Iconografia (*)



Sensor Diferencial de Pressão
Sensor Diferencial de Presión
Capteur Différentielle de Pression
Differential Pressure Sensor
Sensore Differenziale di Pressione



Sistema de Combustão Fechado
Sistema de Combustión Cerrada
Système de Combustion Fermée
Closed Combustion System
Sistema a Combustion Chiusa



Controlo Remoto Incluído
Control Remoto Incluído
Télécommande Incluse
Remote Control Included
Telecomando Incluso



Display Programável
Pantalla Programable
Afficheur Programmable
Programmable Display
Display Programmabili



Opção de Controlo Através de Smartphone
Posibilidad de Contrólar Através de Smartphone
Possibilité de Contrôler Via Smartphone
Possible Smartphone Control
Possibilità di Controllare Tramite Smartphone



Estanque
Estanque
Étanche
Tight
Stagno

(*) Ícones utilizados ao longo do catálogo / Iconos utilizados en el catálogo /
Icônes utilisées dans le catalogue / Icons used throughout the catalogue / Icone utilizzate
in tutto il catalogo.



Ventiladores Potentes e Silenciosos
Ventiladores Potentes y Silenciosos
Ventilateurs Puissants et Silencieux
Powerful and Silent Fan
Ventilatori Potenti e Silenziosi



Total Clean Glass System
Tecnología Cristal Limpio
Technologie Vitre Propre
Total Clean Glass System
Tecnología Vetro Polito



Chapa de Qualidade Seleccionada dos Melhores Lotes
Chapa de Calidad Seleccionada de los Mejores Lotes
Plaque d'Acier de Qualité Sélectionnée Parmi les Meilleurs Lots
Top Quality Steel Plate
Cappa di Alta Qualità Selezionata tra i Migliori Materiali



Interior de Elevada Resistência Térmica
Interior de Elevada Resistencia Térmica
Intérieur de Haute Résistance Thermique
Heat Resistant Interior
Interni Resistenti alle Alte Temperature



Sistema de Auto Limpeza
Sistema de Autolimpieza
Système Auto-nettoyage
Self-cleaning System
Sistema Autopulente



Air Canalizável Opcional
Aire Canalizable Opcional
Optional Ducted Air
Aire Canalisé en Option
Aria Canalizzata Opzionale



CLASSIC



(PT) Novos inseríveis a lenha com ventilação tangencial incluída de série, disponíveis em preto, cinza ou porta em vidro. Incluem porta com sistema de fecho automático, ar externo canalizável através de um kit opcional, dupla combustão e câmara estanque. Possibilidade de regulação da ventilação através de um controlador GLA que, com a inclusão de um Damper, permitirá também o controlo do ar de combustão. Kit wi-fi opcional para gestão do controlador GLA à distância através de smartphone.

(ES) Nuevos insertables de leña con ventilación tangencial incluida de serie, disponibles en negro, gris o con puerta de cristal. Incluyen una puerta con sistema de cierre automático, aire exterior canalizable mediante un kit opcional, doble combustión y cámara estanca. Posibilidad de regular la ventilación a través de un controlador GLA que, con la inclusión de una compuerta, permitirá también el control del aire de combustión. Kit wi-fi opcional para la gestión remota del controlador GLA mediante un smartphone.

(FR) Nouveaux inserts à bois avec ventilation tangentielle inclus de série, disponibles en noir, gris ou porte en verre. Ils comprennent une porte avec système de fermeture automatique, de l'air extérieur qui peut être amené par un kit optionnel, une double combustion et une chambre étanche. Possibilité de réguler la ventilation par un contrôleur GLA qui, avec l'inclusion d'un registre, permettra également de contrôler l'air de combustion. Kit wi-fi en option pour la gestion à distance du contrôleur GLA par smartphone.

(EN) New wood inserts with tangential ventilation included as standard, available in black, grey or glass door. All the models include a door with an automatic closing system, external air that can be piped through an optional kit, dual combustion and an airtight chamber. You can control the ventilation through a GLA controller that, with the inclusion of a damper, also allows to control the combustion air. Optional wi-fi kit for remote management of the GLA controller using a smartphone.



















(IT) Nuovi inserti di legna con ventilazione tangenziale inclusi come standard, disponibili in nero, grigio o porta in vetro. Includono una porta con sistema di chiusura automatica, aria esterna che può essere convogliata attraverso un kit opzionale, doppia combustione e camera stagna. Possibilità di regolare la ventilazione attraverso un controllore GLA che, con l'inclusione di una serranda, permetterà anche il controllo dell'aria di combustione. Kit wi-fi opzionale per la gestione remota del controller GLA tramite smartphone.

CLASSIC





Insertables de Leña / Inserts à Bois / Wood Inserts / Inserti a Legna

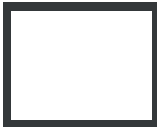

CLASSIC

Série E				E601 M 590 X 546 X 465 mm C Ø 150 mm P 83 Kg  		
					E701 M 690 X 546 X 465 mm C Ø 180 mm P 101 Kg  	
						E801 M 790 X 546 X 465 mm C Ø 200 mm P 116 Kg  
						

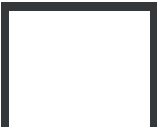
MOLDURAS DISPONÍVEIS CLASSIC Marcos / Encadrements / Frames / Cornice

4 SIDE GLASS - 50 mm	4 SIDE - 45 mm (*)	4 SIDE - 20 mm (*)	3 SIDE GLASS - 50 mm	3 SIDE - 45 mm (*)	3 SIDE - 20 mm (*)
					

(*) Molduras também disponíveis em cinza / Marcos también disponibles en gris / Les cadres sont également disponibles en gris / Frames also available in grey / Cornice disponibili anche in grigio

M: Medidas (LxAxP) / Medidas (AxAxP) / Dimensions (LxHxP) / Dimensions (WxHxD) / Misure (LxAxP)

C: Chaminé / Chimenea / Cheminée / Chimney / Camino

P: Peso / Peso / Poids / Weight / Peso

DESIGN



(PT) Novos inseríveis a lenha com ventilação tangencial opcional, disponíveis em preto ou com porta em vidro. Incluem porta com sistema de fecho automático, ar externo canalizável através de um kit opcional, dupla combustão e câmara estanque. Possibilidade de regulação da ventilação através de um controlador GLA que com a inclusão de um Damper permitirá também o controlo do ar de combustão. Kit wifi opcional para gestão do controlador GLA à distância através de smartphone.

(ES) Nuevos insertables de leña con ventilación tangencial opcional, disponibles en negro o con puerta de cristal. Incluyen puerta con sistema de cierre automático, aire exterior canalizable mediante un kit opcional, doble combustión y cámara estanca. Posibilidad de regular la ventilación a través de un controlador GLA que con la inclusión de una compuerta permitirá también el control del aire de combustión. Kit wifi opcional para la gestión remota del controlador GLA a través del smartphone.

(FR) Nouveaux inserts à bois avec ventilation tangentielle en option, disponibles en noir ou avec porte en verre. Ils comprennent une porte avec système de fermeture automatique, de l'air extérieur qui peut être amené par un kit en option, une double combustion et une chambre étanche. Possibilité de réguler la ventilation par le biais d'un contrôleur GLA qui, avec l'inclusion d'un registre, permettra également de contrôler l'air de combustion. Kit wifi en option pour la gestion à distance du contrôleur GLA via un smartphone.

(EN) New wood inserts with optional tangential ventilation, available in black or with glass door. They include door with automatic closing system, external air that can be piped through an optional kit, dual combustion and airtight chamber. Possibility of regulating ventilation through a GLA controller that with the inclusion of a damper will also allow the control of combustion air. Optional wifi kit for remote management of the GLA controller via smartphone.















(IT) Nuovi inserti in legno con ventilazione tangenziale opzionale, disponibili in nero o con porta in vetro. Includono porta con sistema di chiusura automatica, aria esterna che può essere convogliata attraverso un kit opzionale, doppia combustione e camera stagna. Possibilità di regolare la ventilazione attraverso un controllore GLA che con l'inclusione di una serranda permetterà anche il controllo dell'aria di combustione. Kit wifi opzionale per la gestione remota del controller GLA tramite smartphone.

DESIGN

Insertables de Leña / Inserts à Bois / Wood Inserts / Inserti a Legna



DESIGN

Série E			E609 M 590 X 496 X 465 mm C Ø 150 mm P 94 Kg 			E709 M 690 X 564 X 465 mm C Ø 180 mm P 105 Kg 
	Black + Glass Door	Black + Steel Door		Black + Glass Door	Black + Steel Door	
			E809 M 790 X 636 X 465 mm C Ø 200 mm P 115 Kg 			E909 M 890 X 706 X 465 mm C Ø 200 mm P 137 Kg 
	Black + Glass Door	Black + Steel Door		Black + Glass Door	Black + Steel Door	
Série H			E609H M 590 X 700 X 465 mm C Ø 150 mm P 117 Kg 			
	Black + Glass Door	Black + Steel Door				

MOLDURAS DISPONÍVEIS DESIGN Marcos / Encadraments / Frames / Cornice

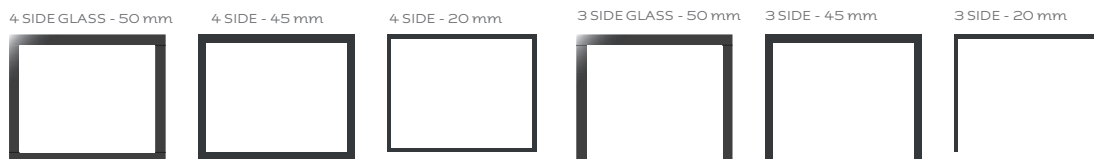

M: Medidas (LxAxP) / Medidas (AxAxP) / Dimensions (LxHxP) / Dimensions (WxHxD) / Misure (LxAxP)
 C: Chaminé / Chimenea / Cheminée / Chimney / Camino
 P: Peso / Peso / Poids / Weight / Peso

OPCIONAIS INSERÍVEIS LENHA

Opcionales de insertables de leña / Options pour inserts à bois / Wood inserts options / Inserti a legna opzionali

A

KIT VENTILAÇÃO / KIT DE VENTILACIÓN /
KIT DE VENTILATION /
VENTILATION KIT /
KIT DI VENTILAZIONE

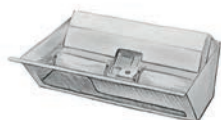

E609 e E609H
160m³/h (*) na posição 2



E709
200 m³/h (*) na posição 2



E809 e E909
420m³/h (*) na posição 5

(PT) Kits de ventilação tangencial e centrífugo opcional para a série Design e Highline para aumentar o débito de ar quente e permitir um aquecimento mais rápido.

(ES) Kits de ventiladores tangenciales e centrífugo opcionales para las series Design y Highline para aumentar el flujo de aire caliente y permitir un calentamiento más rápido.

(FR) Kits de ventilateurs tangentiels et centrifuge en option pour les séries Design et Highline afin d'augmenter le débit d'air chaud et de permettre un réchauffement plus rapide.

(EN) Optional tangential and centrifugal fan kits for the Design and Highline series to increase the flow of hot air and faster warm-up.

(IT) Kit di ventilatori tangenziali e centrifuga opzionali per le serie Design e Highline per aumentare il flusso di aria calda e consentire un riscaldamento più rapido.

* Valores com perda de carga zero Pa. / Valores con pérdida de presión cero Pa. / Valeurs avec perte de charge zéro Pa. / Values with zero Pa pressure drop. / Valori con perdita di carico pari a zero Pa.

B

MESA DE SUPORTE / MESA DE APOYO
/ TABLE D'APPUI / SUPPORT TABLE /
TABELLA DI SUPPORTO



E901, E801, E909, E809



E601, E701, E609, E609H, E709

(PT) Suporte opcional para permitir uma fácil instalação e estabilidade da mesma.

(ES) Soporte opcional que permite una fácil instalación y estabilidad.

(FR) Support optionnel pour permettre une installation facile et la stabilité.

(EN) Optional bracket for easy installation and stability.

(IT) Staffa opzionale per consentire una facile installazione e stabilità.

C

WI-FI KIT



(PT) Permite regular o controlador GLA (ar de combustão + ventilação) à distância através de um smartphone.

(ES) Permite ajustar el controlador GLA (aire de combustión + ventilación) a distancia mediante un smartphone.

(FR) Permet de régler le contrôleur GLA (air de combustion + ventilation) à distance par un smartphone.

(EN) Allows the GLA controller (combustion air + ventilation) to be adjusted remotely using a smartphone.

(IT) Permette la regolazione a distanza della centralina GLA (aria di combustione + ventilazione) utilizzando uno smartphone.

D

KIT DE AR EXTERIOR / KIT DE AIRE EXTERIOR / KIT D'AIR EXTÉRIEUR / EXTERIOR AIR KIT / KIT ARIA ESTERNA



E601, E609, E609H
Ø 80mm



E701, E801, E901, E709,
E809, E909
Ø 100mm

(PT) Para permitir entrada de ar de combustão externo reduzindo o consumo de ar interno, melhorando a qualidade de ar da sua habitação. Ideal para casas muito isoladas ou com sistemas de ventilação.

(ES) Permitir la entrada de aire de combustión externo reduciendo el consumo de aire interno, mejorando la calidad del aire de su hogar. Ideal para casas muy aisladas o con sistemas de ventilación.

(FR) Pour permettre l'admission d'air de combustion externe, réduisant la consommation d'air interne, améliorant ainsi la qualité de l'air de votre maison. Idéal pour les maisons très isolées ou avec des systèmes de ventilation.

(EN) Allows external combustion air intake, reducing internal air consumption, improving the air quality of your home. Ideal for very isolated houses or with ventilation systems.

(IT) Permettere l'ingresso dell'aria di combustione esterna riducendo il consumo d'aria interna, migliorando la qualità dell'aria della vostra casa. Ideale per case molto isolate o con sistemi di ventilazione.

OPCIONAIS INSERÍVEIS LENHA

Opcionales de insertables de leña / Inserts de bois en option / Wood inserts options / Inserti a legna opzionali

E

KIT DAMPER



F

GLA



(PT) Controlador GLA permite controlar a ventilação dos aparelhos de forma fácil. Kit Damper com controlador GLA permite o controlo do ar de combustão dos aparelhos à distância e a ventilação.

(ES) El controlador GLA permite controlar la ventilación de los aparatos de forma sencilla. El kit Damper con controlador GLA permite controlar a distancia el aire de combustión de los aparatos y la ventilación.

(FR) Le contrôleur GLA vous permet de contrôler la ventilation des appareils de manière simple. Le kit de clapet avec contrôleur GLA permet de contrôler à distance l'air de combustion des appareils et la ventilation.

(EN) GLA controller allows you to control the ventilation of the appliances in an easy way. Damper Kit with GLA controller allows remote control of the appliances' combustion air and ventilation.

(IT) Il controller GLA permette di controllare la ventilazione degli apparecchi in modo semplice. Il kit serranda con controllore GLA permette di controllare a distanza l'aria di combustione e la ventilazione degli apparecchi.

G

KIT FIXAÇÃO / KIT DE FIJACIÓN /
KIT DE FIXATION /
FIXATION KIT / KIT DI FISSAGGIO



(PT) Para fixar os recuperadores na parte traseira melhorando a estabilidade da instalação.

(ES) Para fijar los insertables a la parte trasera de la casa y mejorar la estabilidad de la instalación.

(FR) Pour fixer l'appareil au mur, et améliorer la stabilité de l'installation.

(EN) For attaching the stoves to the back, improving the stability of the installation.

(IT) Per fissare le stufe sul retro della casa per migliorare la stabilità dell'installazione.

A E609, E709

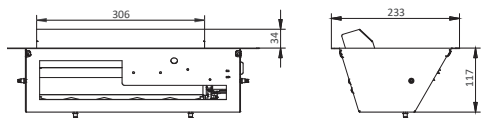

A E809, E909

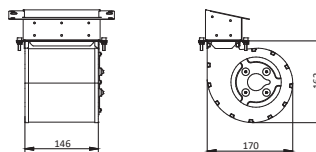

B E901, E801, E909, E809

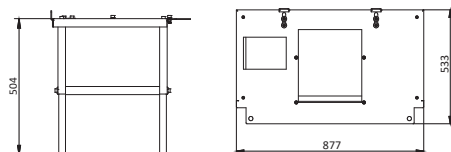

B E601, E701, E609, E609H, E709

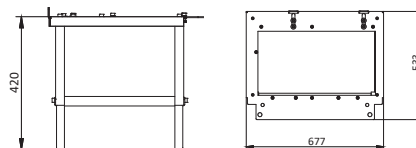

D E601, E609, E609H

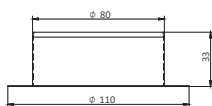

D E701, E801, E901, E709, E809, E909

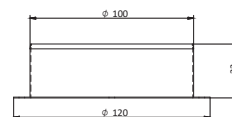

E

F

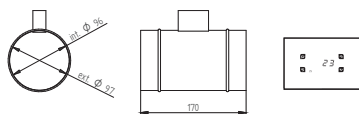

G

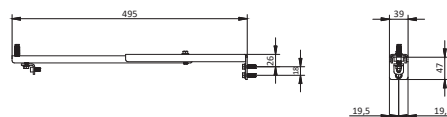

SALAMANDRAS LENHA

Estufas de Leña / Poêles à Bois
Freestanding Wood Stoves / Stufe a Legna



(PT) A gama de salamandras a lenha apresenta um design que se enquadra em todo o tipo de espaços, sejam eles modernos ou clássicos. Com uma combustão perfeita e conexão de ar exterior, são produtos versáteis, com várias opções de acabamento.

(ES) La gama de estufas de leña presenta un diseño que se adapta a todo tipo de espacios, sean modernos o clásicos. Con una combustión perfecta y conexión de aire exterior, son productos versátiles, con varias opciones de acabado.

(FR) La gamme de poêles à bois présente un design qui s'adapte à tous les types d'espaces, qu'ils soient modernes ou classiques. Avec une combustion parfaite et un raccordement à l'air extérieur, ce sont des produits polyvalents, avec diverses options de finition.

(EN) The range of wood-burning stoves features a design that fits all kinds of spaces, whether modern or classic. With perfect combustion and external air connection, they are versatile products, with various finishing options.

(IT) La gamma di stufe a legna ha un design che si adatta a tutti i tipi di spazi, sia moderni che classici. Con una combustione perfetta e un collegamento all'aria esterna, sono prodotti versatili, con varie opzioni di finitura.

SALAMANDRAS LENHA

Estufas de Leña / Poêles à Bois /
Freestanding Wood Stoves / Stufe a Legna



ROUND

Steel
Door



SR500
M Ø 506 X 1153 mm
C Ø 150 mm
P 115 Kg



SR500 + Stone
M Ø 506 X 1185 mm
C Ø 150 mm
P 134 Kg



Glass
Door



Black



Firewood
Door

SR500
M Ø 506 X 1153 mm
C Ø 150 mm
P 115 Kg



Top
Stone

SR500 + Stone
M Ø 506 X 1185 mm
C Ø 150 mm
P 134 Kg



NATURA



S500H + Cork
M 598 X 1043 X 602 mm
C Ø 150 mm
P 132 Kg



S500H + Black Cork
M 598 X 1043 X 602 mm
C Ø 150 mm
P 132 Kg



S500H + Stone
M 598 X 1043 X 602 mm
C Ø 150 mm
P 159 Kg



S500H + Cream
M 544 X 1005 X 602 mm
C Ø 150 mm
P 122 Kg



S500H + Black
M 544 x 1005 x 602 mm
C Ø 150 mm
P 122 Kg



INSERÍVEIS PELLETS

Insertables de Pellets / Inserts à Granulés
Pellet Inserts / Inserti a Pellet



(PT) Os inseríveis a pellets oferecem-lhe toda a comodidade de uma solução de aquecimento moderna, integrando a mais recente tecnologia. Com controlo remoto incluído, possibilidade de controlo através de smartphone, opções de aros de acabamento, display programável e porta com sistema de limpeza. Uma combustão perfeita.

(ES) Los insertables de pellets le ofrecen toda la comodidad de una solución de calefacción moderna, integrando la última tecnología. Con mando a distancia incluido, posibilidad de control a través de smartphone, opciones de marcos de acabado, pantalla programable y puerta con sistema de limpieza. Una combustión perfecta.

(FR) Les inserts à granulés vous offrent tout le confort d'une solution de chauffage moderne, intégrant les dernières technologies. Avec télécommande incluse, possibilité de contrôle par smartphone, options de jantes de finition, affichage programmable et porte avec système de nettoyage. Une combustion parfaite.

(EN) Pellet inserts offer you all the convenience of a modern heating solution, integrating the latest technology. With remote control included, possibility of control via smartphone, finishing frame options, programmable display and door with cleaning system. A perfect combustion.

(IT) Gli inserti a pellet vi offrono tutta la comodità di una soluzione di riscaldamento moderna, integrando le ultime tecnologie. Con telecomando incluso, possibilità di controllo tramite smartphone, opzioni di finitura del bordo, display programmabile e porta con sistema di pulizia. Una combustione perfetta.

INSERÍVEIS PELLETS

Insertables de Pellets / Inserts à granulés / Pellet inserts / Inserti a Pellet



SQUARE

Série D



A

SQUARE D 9KW
M 688 X 601 X 573 mm
C Ø 80 mm
P 114 Kg



Série V



B

SQUARE V 9KW
M 688 X 561 X 573 mm
C Ø 80 mm
P 115,5 Kg



SQUARE V9 & D9 OPTIONS

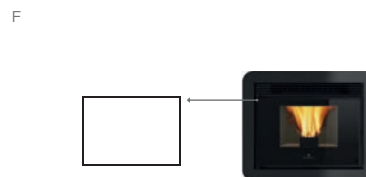
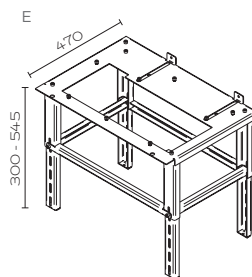
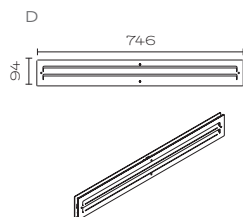

SQUARE V9 OPTIONS

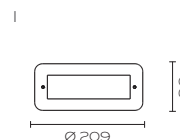
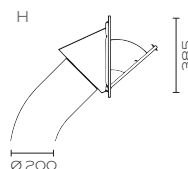
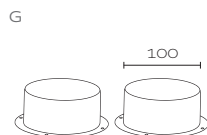

- A: Carregamento através de gaveta / Carga a través de bandeja / Tiroir de chargement frontal / Front pellet feed drawer / Caricamento pellet da cassetto frontale
 B: Carregamento Lateral / Carga Lateral / Chargement latéral / Side loading / Caricamento lateral
 C: Chaminé / Chimenea / Cheminée / Chimney / Camino
 D: Grelha de ventilação / Rejilla de ventilación / Grille de ventilation / Ventilation grid / Griglia di ventilazione
 E: Mesa de suporte / Mesa de soporte / Table d'appui / Support table / Supporto da tavolo
 F: Friso preto / Friso negro / Cadre noir / Black trim / Fregio nero
 G: Bocas de saída / Bocas de salida / Bouches de sortie / Ducted air outlets / Bocche di uscita
 M: Medidas (LxAxP) / Medidas (AxAxP) / Dimensions (LxHxD) / Dimensions (WxHxD) / Misure (LxAxP)
 H: Tubo de carregamento pellets / Tubo de carga de pellets / Tube de chargement de granulés / Lateral loading kit / Tubo di carico pellet
 I: Aro do display / Marco para el display / Cadre pour display / Frame for display / Cornice per il display
 P: Peso / Peso / Poids / Weight / Peso

SALAMANDRAS PELLETS

Estufas de Pellets / Poêles à granulés
Pellet Stoves / Stufe a Pellet



(PT) As salamandas a pellets estão disponíveis em porta em chapa e porta em vidro, com várias cores de acabamento para as capas laterais. Com as habituais comodidades tais como ligação ao seu smartphone, controlo remoto e display programável para aumentar o seu conforto.

(ES) Las estufas de pellets están disponibles en puerta de chapa y puerta de cristal, con varios colores de acabado para las tapas laterales. Con las comodidades habituales, como la conexión con tu smartphone, el mando a distancia y la pantalla programable para aumentar tu confort.

(FR) Les poêles à pellets sont disponibles avec une porte en acier et une porte en verre, avec différentes couleurs de finition pour les habillages latéraux. Avec les commodités habituelles telles que la connexion à votre smartphone, la télécommande et l'affichage programmable pour augmenter votre confort.

(EN) The pellet stoves are available in normal or glass door, with various finishing colours for the side covers. With the usual amenities such as connection to your smartphone, remote control and programmable display to increase your comfort.

(IT) Le stufe a pellet sono disponibili con porta in lamiera e porta in vetro, con vari colori di finitura per le coperture laterali. Con i soliti servizi come la connessione al tuo smartphone, il telecomando e il display programmabile per aumentare il tuo comfort.

SALAMANDRAS PELLETS

Estufas de Pellets / Poêles à granulés
Pellet Stoves / Stufe a Pellet



TUBE

Steel Door



T500
M 500 x 1072 x 561 mm
C Ø 80 mm
P 94 Kg



Glass Door



Glass Black Bordeaux White

T500
M 500 x 1072 x 561 mm
C Ø 80 mm
P 94 Kg



FRAME 8 KW

Steel Door



T300
M 530 X 984 X 564 mm
C Ø 80 mm
P 75 Kg



Glass Door



Oak Cream Bordeaux White

T300
M 530 X 984 X 564 mm
C Ø 80 mm
P 75 Kg



FRAME 10 KW

Steel Door



T400
M 530 X 1100 X 566 mm
C Ø 80 mm
P 110 Kg



Glass Door



Oak Cream Bordeaux White

T400
M 530 X 1100 X 566 mm
C Ø 80 mm
P 110 Kg



M: Medidas (LxAxP) / Medidas (AxAxP) / Dimensions (LxHxP) / Dimensions (WxHxD) / Misure (LxAxP)

C: Chaminé / Chimenea / Cheminée / Chimney / Camino P: Peso / Peso / Poids / Weight / Peso

(*) A certificação CSTB apenas se aplica à versão estanque. / La certificación CSTB sólo se aplica a la versión estanca. / La certification du CSTB ne s'applique qu'à la version étanche. / The CSTB certification only applies to the airtight version. / La certificazione CSTB si applica solo alla versione stagna.

SALAMANDRAS PELLETS ESTANQUES

Estufas de Pellets Herméticas / Poêles à Granulés Étanches /
Airtight Pellet Stoves / Stufe a Pellet Stagna



(PT) As salamandas a pellets estanques retiram o ar do exterior da habitação e estão disponíveis em porta em chapa, porta em vidro e a nova porta Nightview. A nova gama Urban, disponível nas potências 8, 10 e 12kW, dispõe de fecho automático de porta, display touch oculto, abertura da cuba de pellets aumentada para maior flexibilidade de carga, resistência cerâmica, cuba de pellets isolada e extrator estanque - Sistema estanque. O modelo de 12 kW permite ar canalizado.

(ES) Las estufas de pellets herméticas extraen el aire del exterior de la vivienda y están disponibles con puerta normal, puerta de cristal y la nueva puerta Nightview. La nueva gama Urban, disponible en las potencias de 8, 10 y 12 kW, cuenta con cierre automático de la puerta, una pantalla táctil oculta, una apertura del depósito de pellets ampliada para una mayor flexibilidad de carga, una resistencia cerámica, un depósito de pellets aislado y un extractor estanque - Sistema Airtight. El modelo de 12 kW puede ser canalizado.

(FR) Les poêles à granulés étanches aspirent l'air de l'extérieur de la maison et sont disponibles avec une porte en acier, une porte en verre et la nouvelle porte Nightview. La nouvelle gamme Urban, disponible dans les puissances de 8, 10 et 12 kW, dispose d'une fermeture automatique de la porte, d'un écran tactile caché, d'une ouverture agrandie du réservoir à pellets pour une plus grande flexibilité de chargement, d'un élément chauffant en céramique, d'un réservoir à pellets isolé et d'un extracteur étanche - Système Airtight. Le modèle de 12 kW permet l'utilisation d'air canalisé.

(EN) The airtight pellet stoves draw air from the outside of the home and are available with a normal door, glass door and the new Nightview door. The new Urban range, available with output powers of 8, 10 and 12 kW has an automatic door closing system, a hidden touch display, an enlarged pellet tank opening for greater loading flexibility, a ceramic heating element, an insulated pellet tank and an Airtight extractor - Airtight system. The 12 kW model allows ducted air.

(IT) Le stufe a pellet a tenuta d'aria aspirano l'aria dall'esterno della casa e sono disponibili con porta in lamiera, porta in vetro e la nuova porta Nightview. La nuova gamma Urban, disponibile nelle capacità di 8, 10 e 12 kW, ha una chiusura automatica della porta, un display tattile nascosto, un'apertura del serbatoio di pellet allargata per una maggiore flessibilità di carico, un elemento di riscaldamento in ceramica, un serbatoio di pellet isolato e un estrattore stagno - Airtight system. Il modello da 12 kW permette l'aria canalizzata di riscaldamento in ceramica, un serbatoio di pellet isolato e un estrattore stagno - Airtight system.

SALAMANDRAS PELLETS ESTANQUES

URBAN 8 KW

Estufas de Pellets Herméticas / Poêles à Granulés
Étanches / Airtight Pellet Stoves /
Stufe a Pellet Stagna



Steel
Door



T301
M 522 X 1005 X 533 mm
C Ø 80 mm
P 143 Kg



Glass
Door



T301
M 522 X 1005 X 533 mm
C Ø 80 mm
P 143 Kg



URBAN 10 KW

Steel
Door



T401
M 522 X 1105 X 533 mm
C Ø 80 mm
P 155 Kg



Glass
Door



T401
M 522 X 1105 X 533 mm
C Ø 80 mm
P 155 Kg



URBAN 12 KW

Steel
Door



T601
M 574 X 1155 X 563 mm
C Ø 80 mm
P 193 Kg



Glass
Door



T601
M 574 X 1155 X 563 mm
C Ø 80 mm
P 193 Kg



M: Medidas (LxAxP) / Medidas (AxAxP) / Dimensions (LxHxP) / Dimensions (WxHxD) / Misure (LxAxP)
C: Chaminé / Chimenea / Cheminée / Chimney / Camino P: Peso / Peso / Poids / Weight / Peso

(*) A certificação CSTB apenas se aplica à versão estanque. / La certificación CSTB sólo se aplica a la versión estanca. / La certification du CSTB ne s'applique qu'à la version étanche. / The CSTB certification only applies to the airtight version. / La certificazione CSTB si applica solo alla versione stagna.



TUBE ESTANQUE hermética / étanche / airtight / stagna

CSTB
Certification

(PT) Nova Tube Estanque 9kW, com kit de ventilação opcional. Máquina estanque certificada no CSTB disponível em cor preta, branca e bordeaux e também com acabamento em vidro negro.

(ES) Nuevo tubo estanco de 9kW, con kit de ventilación opcional. Máquina estanca certificada por el CSTB, disponible en color negro, blanco y burdeos y también con acabado de cristal negro.

(FR) Nouveau Tube étanche 9kW, avec kit de ventilation en option. Machine étanche certifiée par le CSTB, disponible en noir, blanc et bordeaux et également avec une finition en verre noir.

(EN) New Airtight Tube 9kW, with optional ventilation kit. CSTB certified Airtight machine available in black, white and bordeaux colour and also with black glass finish.

(IT) Nuovo Airtight Tube 9kW, con kit di ventilazione opzionale. Macchina a tenuta stagna certificata CSTB disponibile nei colori nero, bianco e bordeaux e anche con finitura in vetro nero.

Steel
Door



T500 AIRTIGHT

M 500 x 1072 x 561 mm
C Ø 80 mm
P 94 Kg



Glass
Door



Glass

Black

Bordeaux

White

T500 AIRTIGHT

M 500 x 1072 x 561 mm
C Ø 80 mm
P 94 Kg



M: Medidas (LxAxP) / Medidas (AxAxP) / Dimensions (LxHxP) / Dimensions (WxHxD) / Misure (LxAxP)

C: Chaminé / Chimenea / Cheminée / Chimney / Camino

P: Peso / Peso / Poids / Weight / Peso

26

Molduras

Marcos / Encadrements / Frames / Cornice

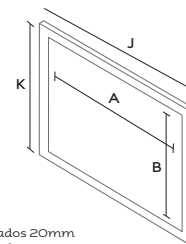

		4 lados vidro 50mm 4 lados cristal 50mm 4 côtés verre 50mm 4 sided glass 50mm 4 lati vetro 50mm				4 lados 45mm 4 lados 45mm 4 côtés 45mm 4 sided 45mm 4 lati 45mm		4 lados 20mm 4 lados 20mm 4 côtés 20mm 4 sided 20mm 4 lati 20mm		3 lados vidro 50mm 3 lados cristal 50mm 3 côtés verre 50mm 3 sided glass 50mm 3 lati vetro 50mm		3 lados 45mm 3 lados 45mm 3 côtés 45mm 3 sided 45mm 3 lati 45mm		3 lados 20mm 3 lados 20mm 3 côtés 20mm 3 sided 20mm 3 lati 20mm	
Dimensões (em mm)		A	B	J	K	J	K	J	K	J	K	J	K	J	K
CLASSIC	E601	587	536	687	636	677	626	627	576	687	586	677	581	627	556
	E701	687	536	787	636	777	626	727	576	787	586	777	581	727	556
	E801	787	536	887	636	877	626	827	576	887	586	877	581	827	556
	E901	887	536	987	636	977	626	927	576	987	586	977	581	927	556
DESIGN	E609	588	488	688	588	678	578	628	528	688	538	678	533	628	508
	E709	688	556	788	656	778	646	728	596	788	606	778	601	728	576
	E809	788	628	888	728	878	718	828	668	888	678	878	673	828	648
	E909	888	698	988	798	978	788	928	738	988	748	978	743	928	718
	E609H	587	690	687	790	677	780	627	730	687	740	677	735	627	710
		4 lados 44mm 4 lados 44mm 4 côtés 44mm 4 sided 44mm 4 lati 44mm				4 lados de 74mm 4 lados de 74mm 4 côtés de 74mm 4 sided 74mm 4 lati 74mm		3 lados 44mm 3 lados 44mm 3 côtés de 44mm 3 sided 44mm 3 lati 44mm		4 lados 50mm 4 lados 50mm 4 côtés de 50mm 4 sided 50mm 4 lati 50mm					
Dimensões (em mm)		A	B	J	K	J	K	J	K	J	K				
SQUARE	D9KW	685	596	773	684	833	744	773	640	785	696				
	V9KW	685	536	773	624	833	684	773	580	785	636				

CLASSIC AND DESIGN

4 SIDE GLASS - 50 mm



4 SIDE - 45 mm

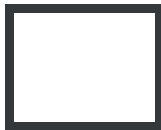

4 SIDE - 20 mm



3 SIDE GLASS - 50 mm



3 SIDE - 45 mm

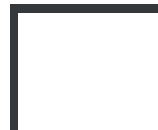

3 SIDE - 20 mm



SQUARE

4 SIDE - 44 mm



4 SIDE - 74 mm



3 SIDE - 44 mm



4 SIDE GLASS - 50 mm



4 SIDE GLASS - 74 mm



Características

Características / Caractéristiques /
Technical specifications / Caratteristiche tecniche

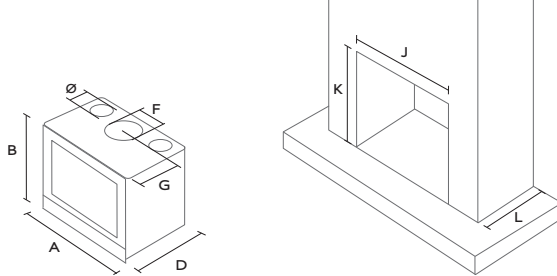

INSERÍVEIS LENHA Insertables de Leña / Inserts à Bois / Wood Inserts / Inserti a Legna

		(mm)							Características / Caraterísticas / Carateristiques / Characteristics / Caratteristiche									
		Caixa de Combustão Caja de Combustión Chambre de Combustion Combustion Chamber Cassa di Combustione			Chaminé Chimenea Cheminée Chimney Camino		Lareira Hogar Dimension foyer mini Chimney Camino											
		A	B	D	F	G	J	K	L(*)	η (%)	P (Kg)	Ø (mm)	Pu (kW)	CO 13% O2 (%) (**)	CO2 (%)	Pn (kW)	Cl (Kg/Hora)	V (m3)
CLASSIC	E601	590	546	465	150	275	607-680	559-609	500	77	83	100	5,6-10,4	0,077	8,9	8	2,4	182
	E701	690	546	465	180	275	707-780	559-609	500	78	101	100	6,5-12,1	0,070	9,3	9,3	2,8	211
	E801	790	546	465	200	275	807-880	559-609	500	79	116	100	7,4-13,8	0,063	9,7	10,6	3,1	241
	E901	890	546	465	200	275	907-980	559-609	500	80	122	100	8,3-15,5	0,056	10,1	11,9	3,5	270
DESIGN	E609	590	496	465	150	288	607-680	509-530	500	76	94	100	5,6-10,4	0,067	9,1	8	2,4	182
	E709	690	564	465	180	275	707-780	577-600	500	76	105	100	6,6-12,2	0,070	8,6	9,4	2,8	214
	E809	790	636	465	200	275	807-880	649-670	500	77	115	100	7,5-13,9	0,074	8,1	10,7	3,3	243
	E909	890	706	465	200	275	907-980	719-740	500	77	137	100	8,5-15,7	0,077	7,7	12,1	3,7	275
	E609H	590	700	465	150	285	607-680	713-734	500	76	117	100	5,6-10,4	0,067	9,1	8,0	2,4	182

INSERÍVEIS PELLETS Insertables de Pellets / Inserts à granulés / Pellet Inserts / Inserti a Pellet

		(mm)							Características / Caraterísticas / Carateristiques / Characteristics / Caratteristiche												
		Caixa de Combustão Caja de Combustión Chambre de Combustion Combustion Chamber Cassa di Combustione			Chaminé Chimenea Cheminée Chimney Camino		Lareira Hogar Dimension foyer mini Chimney Camino														
		A	B	D	F	G	J	K	L	η (%)	ηf (%)	Pn (kW)	Pr (kW)	Dp (Kg)	CM (Kg/Hora)	Cm (Kg/Hora)	Ø (mm)	V (m3)	CO 13% O2 (%) (**)	p (Kg)	
SQUARE	D 9KW	688	601	573	80	517	693	611	577	90	96	8,3	3,2	15,0	1,9	0,7	N.A.	189	0,01	114	
	V 9KW	688	561	573	80	517	693	571	577	90	96	8,3	3,2	15,0	1,9	0,7	100	189	0,01	115,5	

(*) Medidas não considerando conexão de ar exterior na parte inferior do equipamento. / Medidas no considerando la conexión de aire externo en la parte inferior de la unidad. / Mesures ne tenant pas compte de la connexion d'air extérieur au bas de l'appareil. / Measures without considering external air connection in the lower part of the unit.

(**) CO 13 % O2 % de CO a potência nominal. / CO 13 % O2 % de CO a potencia nominal. / CO 13 % O2 % de CO à puissance nominal. / CO 13 % O2 % de CO at nominal power. / CO 13 % O2 % de CO potenza nominal.

η: Rendimento potencia nominal / Rendimento potencia nominal / Rendement puissance nominal / Efficiency at nominal power / Rendimento potenza nominale

ηf: Rendimento potencia reduzida / Rendimiento potencia reducida / Rendement puissance réduite / Efficiency at reduced power / Rendimento potenza ridotta

Pn: Potência nominal / Potencia nominal / Puissance nominale / Rated power / Potenza nominale

Pr: Potência Reduzida / Potencia a bajo consumo / Puissance réduite / Low power heat / Potenza ridotta

Dp: Depósito de pellets / Depósito de pellets / Réservoir granules / Pellet tank / Deposito pellet

CM: Consumo máximo de pellets / Consumo máximo pellets / Consommation maximale granulés / Maximum pellet consumption / Consumo massimo pellets

Cm: Consumo mínimo de pellets / Consumo reducido pellets / Consommation minimum granulés / Minimum pellet consumption / Consumo ridotto pellets

Ø: Saídas de ar / Salidas de aire / Sorties d'air / Air outlets / Uscita aria

Pu: Potência Utilização / Potencia utilización / Puissance utilisation / Operating power / Potenza utile

Pn: Potência nominal / Potencia nominal / Puissance nominale / Rated power / Potenza nominale

Cl: Consumo lenha / Consumo de leña / Consommation de bois / Wood consumption / Consumo di legna

V: Volume máximo aquecido / Volumen calentado máximo / Volume chauffé maximum / maximum heated volume / Volume riscaldabile massimo

P: Peso / Peso / Poids / Weight / Peso

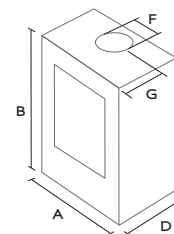

SALAMANDRAS LENHA Estufas de Leña / Poêles à Bois / Freestanding Wood Stoves / Stufe a Legna

		(mm)					Características / Caraterísticas / Carateristiques / Characteristics / Caratteristiche							
		Caixa de Combustão Caja de Combustión Chambre de Combustion Combustion Chamber Cassa di Combustione			Chaminé Chimenea Cheminée Chimney Camino		η (%)	P (Kg)	Pu (kW)	CO 13% O2 (%)(***)	CO ₂ (%)	Pn (kW)	Cl (Kg./Hora)	V (m3)
		A	B	D	F	G								
ROUND	SR500 Steel	Ø506	1153	Ø506	150	353	81	115	5,1 - 9,5	0,07	8,7	7,3	1,6	166
	SR500 Stone	Ø506	1185	Ø506	150	353	81	134	5,1 - 9,5	0,07	8,7	7,3	1,6	166
NATURA	S500H Cork	598	1043	602	150	N.A	81	132	5,1 - 9,5	0,07	8,7	7,3	1,6	166
	S500H Stone	598	1043	602	150	N.A	81	159	5,1 - 9,5	0,07	8,7	7,3	1,6	166
	S500H Color	544	1005	602	150	N.A	81	122	5,1 - 9,5	0,07	8,7	7,3	1,6	166

SALAMANDRAS PELLETS Estufas de Pellets / Poêles à granulés / Pellet Stoves / Stufe a Pellet

		(mm)					Características / Caraterísticas / Carateristiques / Characteristics / Caratteristiche										
		Caixa de Combustão Caja de Combustión Chambre de Combustion Combustion Chamber Cassa di Combustione			Chaminé Chimenea Cheminée Chimney Camino		η (%)	ηf (%)	Pn (kW)	Pr (kW)	Dp (Kg)	CM (Kg./Hora)	Cm (Kg./Hora)	Ø (mm)	V (m3)	CO 13% O2 (%)(***)	P (Kg)
		A	B	D	F	G											
TUBE (**)	T500	Ø500	1072	561	80	N.A.	91	96	8,8	3,0	17,5	2,0	0,70	100 (*)	200	0,01	94
FRAME	T300	530	984	564	80	N.A.	91	96	8,0	3,0	15,0	1,8	0,70	N.A.	182	0,01	75
	T400	530	1100	566	80	N.A.	91	96	10,0	3,5	17,0	2,3	0,80	N.A.	227	0,03	110
URBAN	T301	522	1005	533	80	N.A.	91	96	8,0	3,0	15,0	1,8	0,68	N.A.	182	0,01	143
	T401	522	1105	533	80	N.A.	91	96	10,0	3,5	17,0	2,3	0,77	N.A.	227	0,01	155
	T601	574	1155	563	80	N.A.	92	96	11,9	3,9	30,0	2,7	0,90	100 (*)	269	0,02	193

(*) Com kit de ventilação opcional. / Con kit de ventilación opcional. / Avec kit de ventilation en option. / With optional ventilation kit. / Con kit di ventilazione opzionale.

(**) Opção estanque / Opción estanque / Option étang / Tight option / Optione stagno

(***) CO 13 % O₂ % de CO a potência nominal. / CO 13 % O₂ % de CO a potencia nominal. / CO 13 % O₂ % de CO à puissance nominale. / CO 13 % O₂ % of CO at nominal power. / CO 13 % O₂ % de CO potenza nominal.

η: Rendimento potencia nominal / Rendimiento potencia nominal / Rendement puissance nominale / Efficiency at nominal power / Rendimento potenza nominale

ηf: Rendimento potencia reduzida / Rendimiento potencia reducida / Rendement puissance réduite / Efficiency at reduced power / Rendimento potenza ridotta

Pn: Potência nominal / Potencia nominal / Puissance nominale / Rated power / Potenza nominale

Pr: Potência Reduzida / Potencia a bajo consumo / Puissance réduite / Low power heat / Potenza ridotta

Dp: Depósito de pellets / Depósito de pellets / Réservoir granulés / Pellet tank / Deposito pellet

CM: Consumo máximo de pellets / Consumo máximo pellets / Consommation maximale granulés / Maximum pellet consumption / Consumo massimo pellets

Cm: Consumo mínimo de pellets / Consumo reducido pellets / Consommation minimum granulés / Minimum pellet consumption / Consumo ridotto pellets

Ø: Saídas de ar / Salidas de aire / Sorties d'air / Air outlets / Uscita aria

Pu: Potência Utilização / Potencia utilización / Puissance utilisation / Operating power / Potenza utile

Pr: Potência nominal / Potencia nominal / Puissance nominale / Rated power / Potenza nominale

Cl: Consumo lenha / Consumo de leña / Consommation de bois / Wood consumption / Consumo di legna

V: Volume máximo aquecido / Volumen calentado máximo / Volume chauffé maximum / maximum heated volume / Volume riscaldabile massimo

P: Peso / Peso / Poids / Weight / Peso

Desenhos Técnicos

Sorteios técnicos / Dessins techniques / Technical drawings / Disegni tecnici

CLASSIC

INSERÍVEIS LENHA Insertables de Leña / Inserts à Bois / Wood Inserts / Inserti a Legna

E601
Serie
E

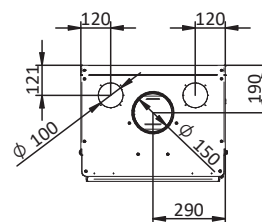
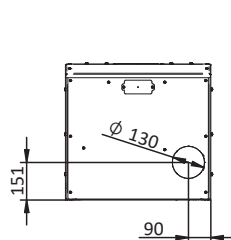
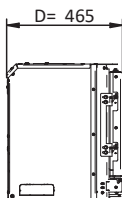
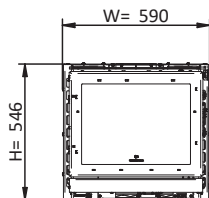

E701
Serie
E

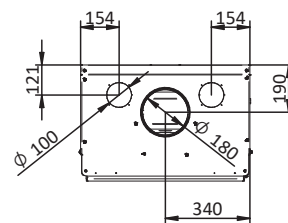
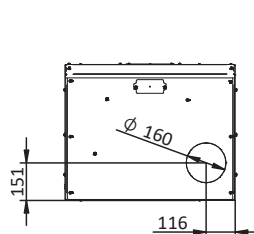
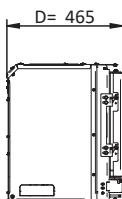
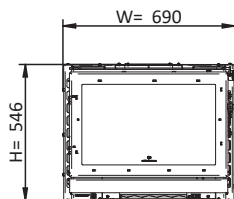

E801
Serie
E

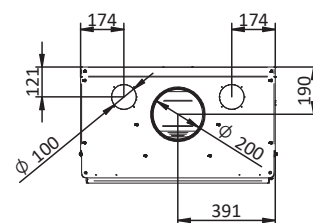
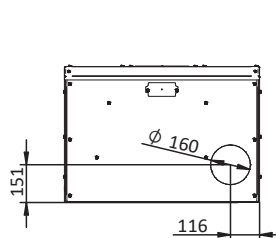
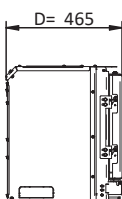
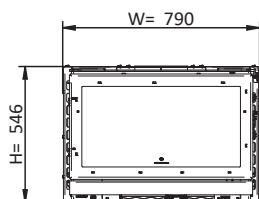

E901
Serie
E

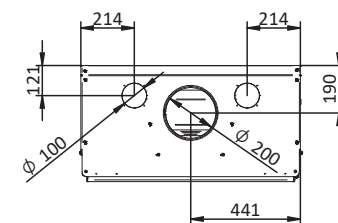
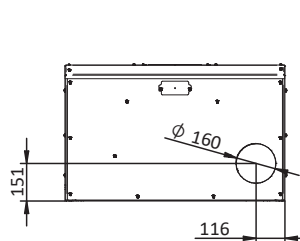
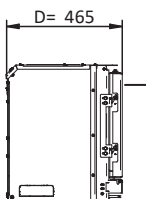
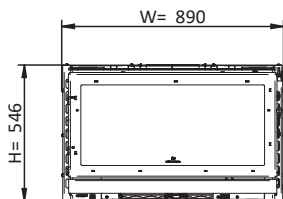

DESIGN

INSERÍVEIS LENHA Insertables de Leña / Inserts à Bois/ Wood Inserts / Inserti a Legna

E609
Serie
E

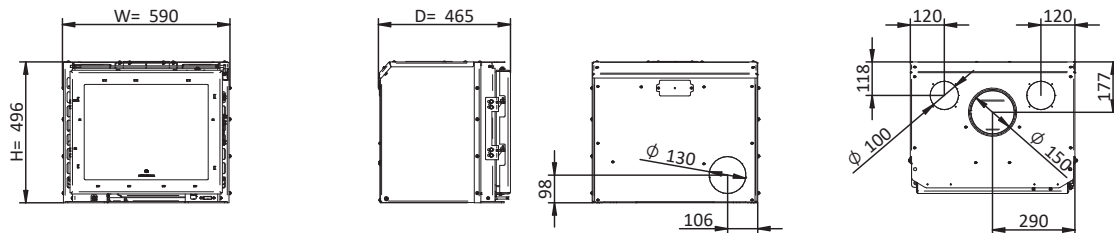

E709
Serie
E

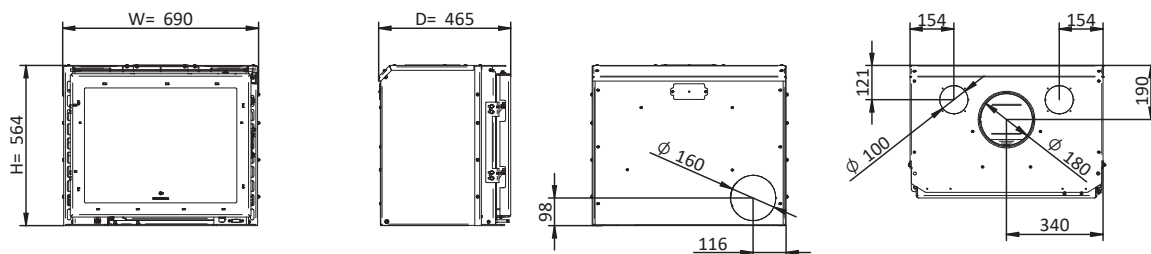

E809
Serie
E

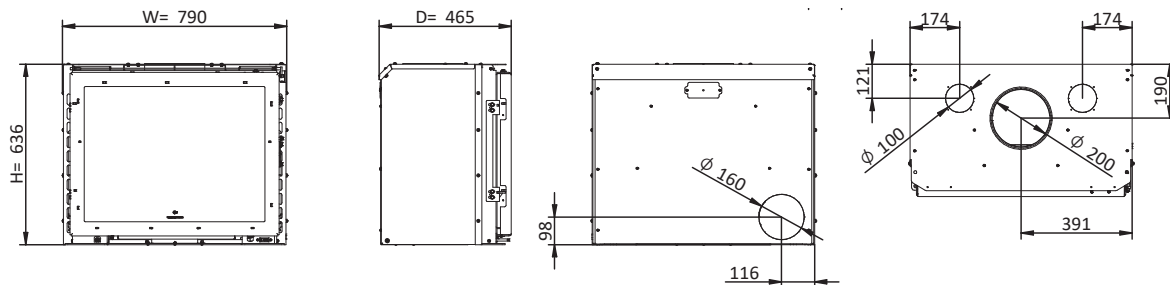

E909
Serie
E

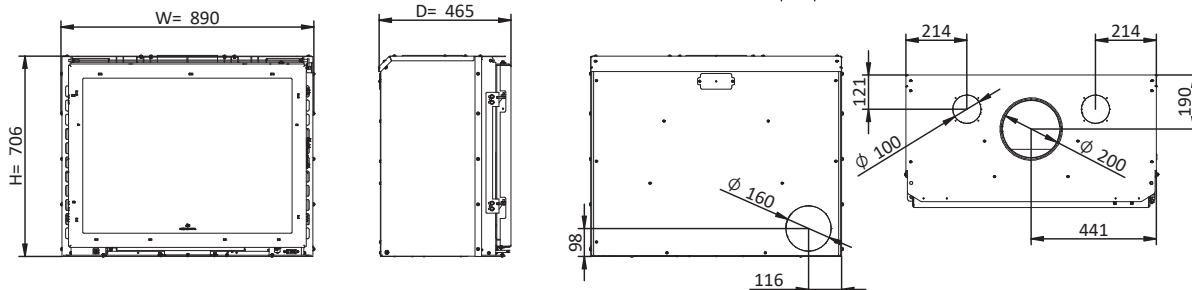

Desenhos Técnicos

Sorteos técnicos / Dessins techniques / Technical drawings / Disegni tecnici

DESIGN

INSERÍVEIS LENHA Insertables de Leña / Inserts à Bois / Wood Inserts / Inserti a Legna

E609
Serie
H

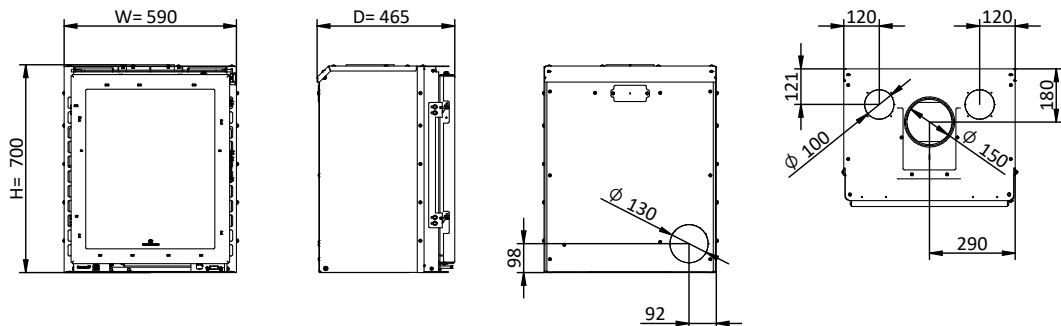

ROUND

SALAMANDRAS LENHA Estufas de Leña / Poêles à Bois / Freestanding Wood Stoves / Stufe a Legna

SR500

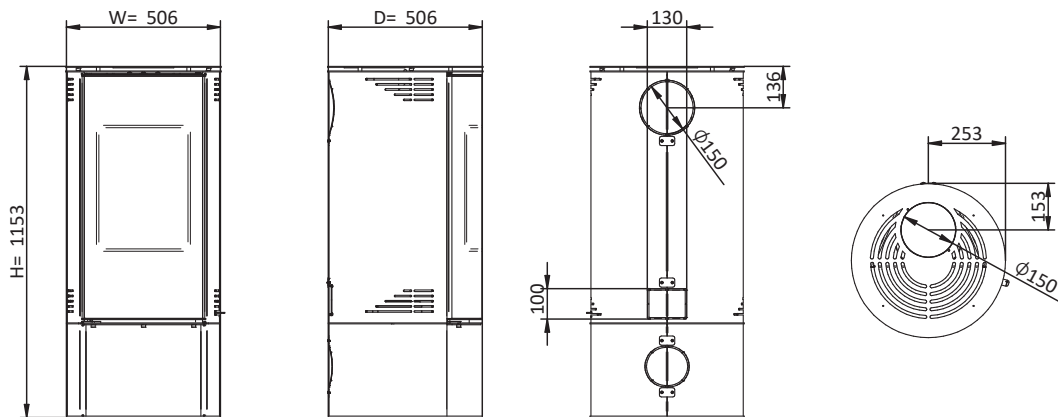

NATURA

SALAMANDRAS LENHA Estufas de Leña / Poêles à Bois / Freestanding Wood Stoves / Stufe a Legna

S500H
Cork

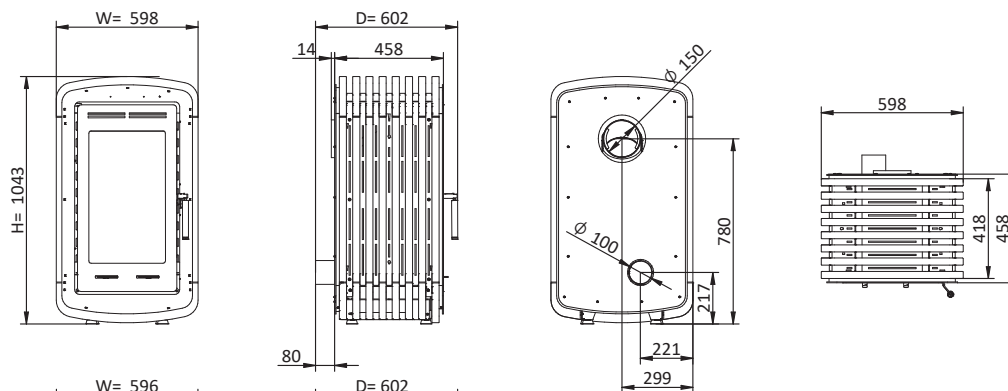

S500H
Stone

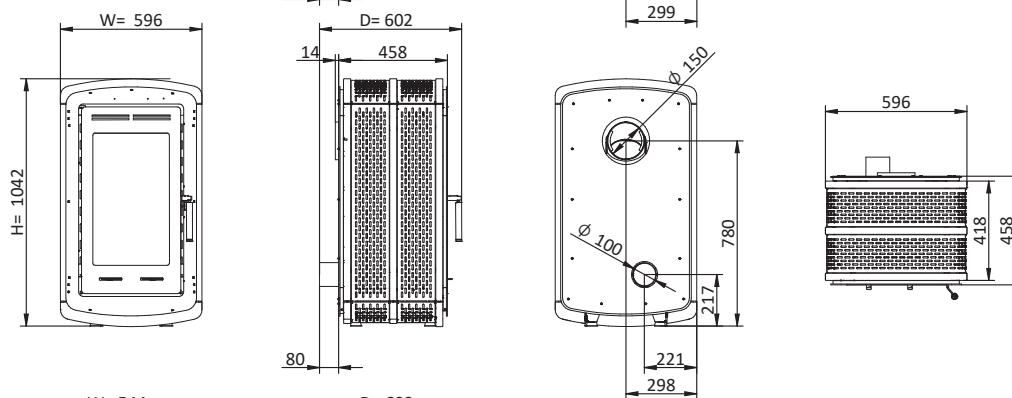

S500H
Color

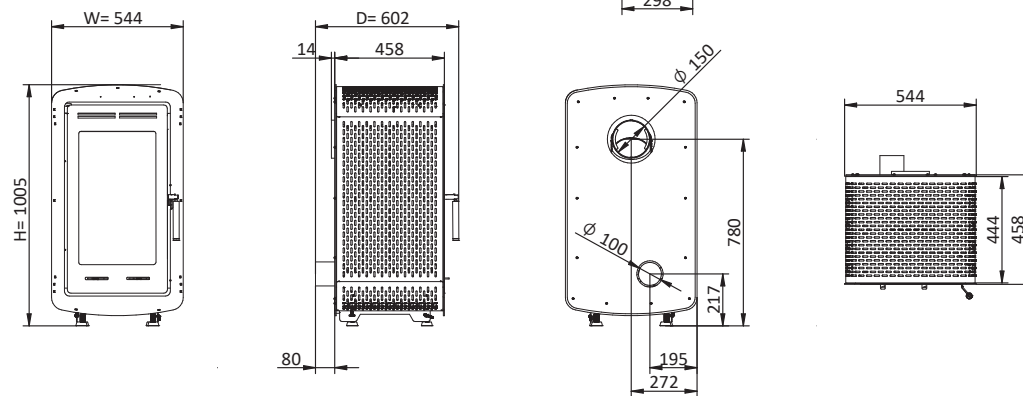

Desenhos Técnicos

Sorteos técnicos / Dessins techniques / Technical drawings / Disegni tecnici

SQUARE

INSERÍVEIS PELLETS Insertables de Pellets / Inserts à granulés / Pellet Inserts / Inserti a Pellet

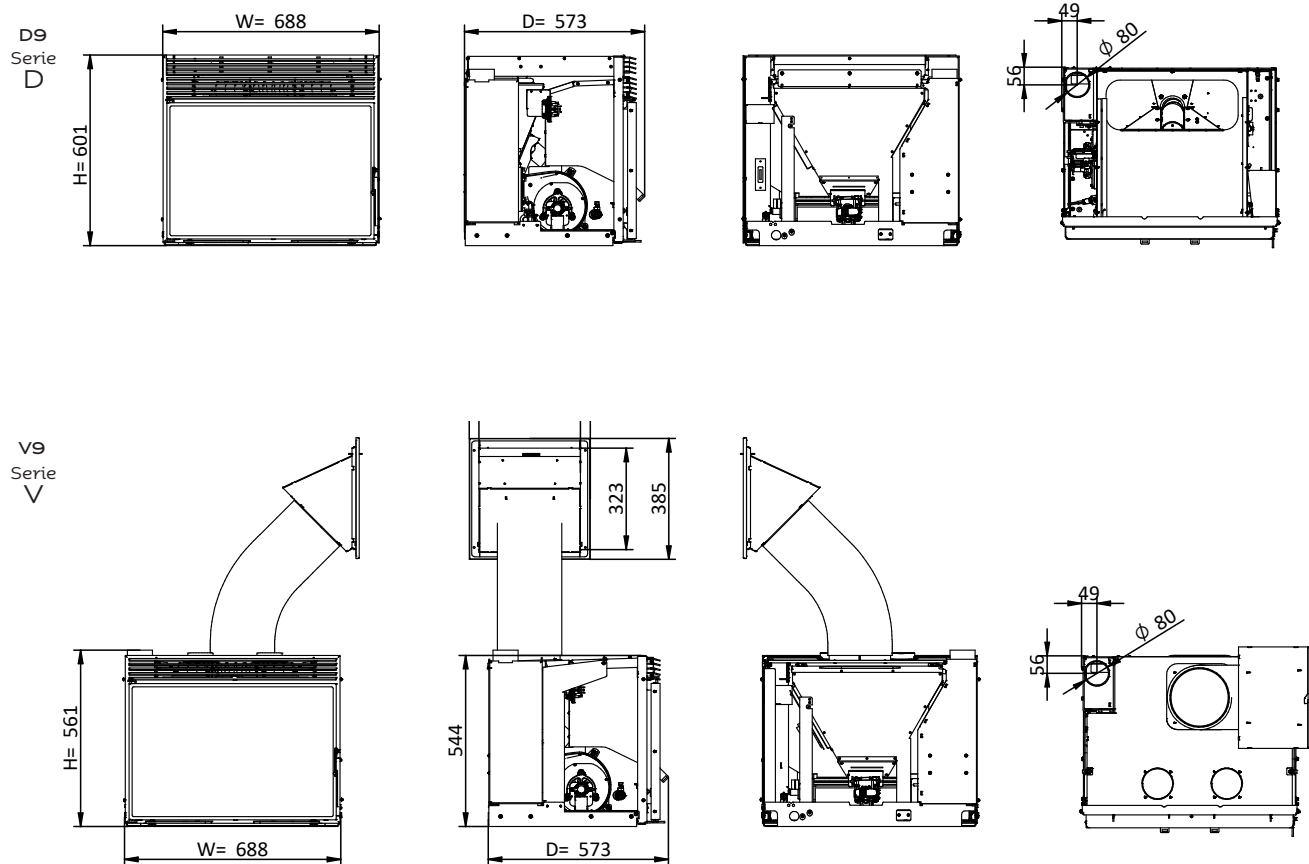

TUBE

INSERÍVEIS PELLETS Insertables de Pellets / Inserts à granulés / Pellet Inserts / Inserti a Pellet

T500

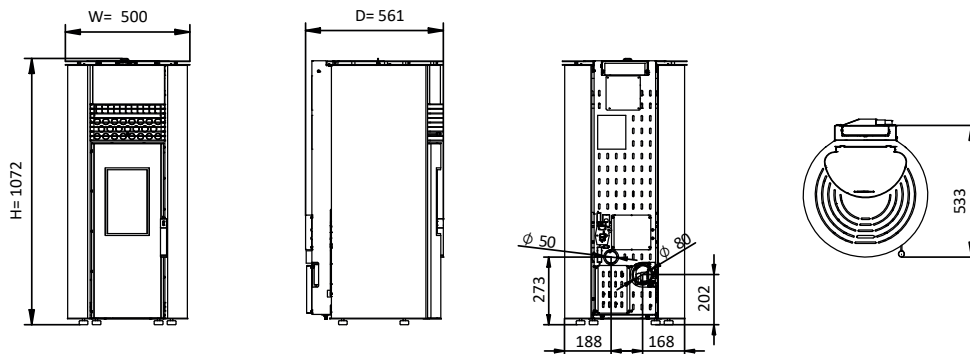

FRAME

SALAMANDRAS PELLETS Estufas de Pellets / Poêles à granulés / Pellet Stoves / Stufe a Pellet

T300

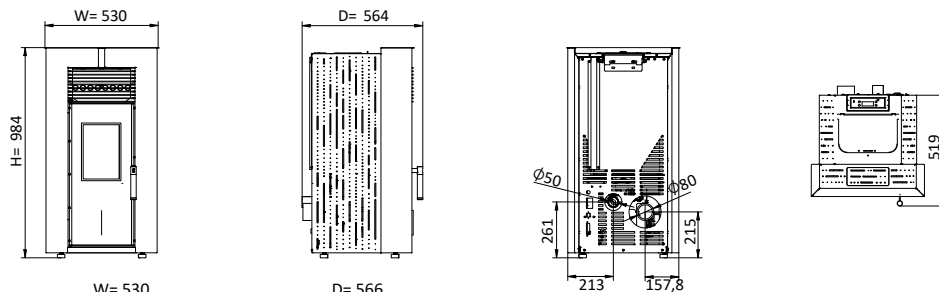

T400

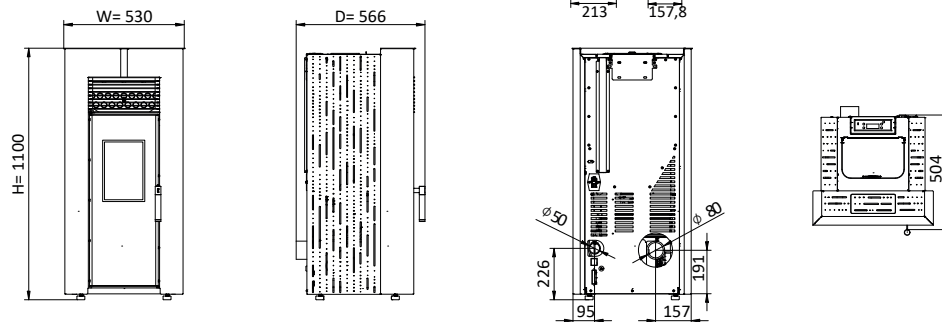

Desenhos Técnicos

Sorteos técnicos / Dessins techniques / Technical drawings / Disegni tecnici

URBAN

SALAMANDRAS PELLETS Estufas de Pellets / Poêles à granulés / Pellet Stoves / Stufe a Pellet

T301

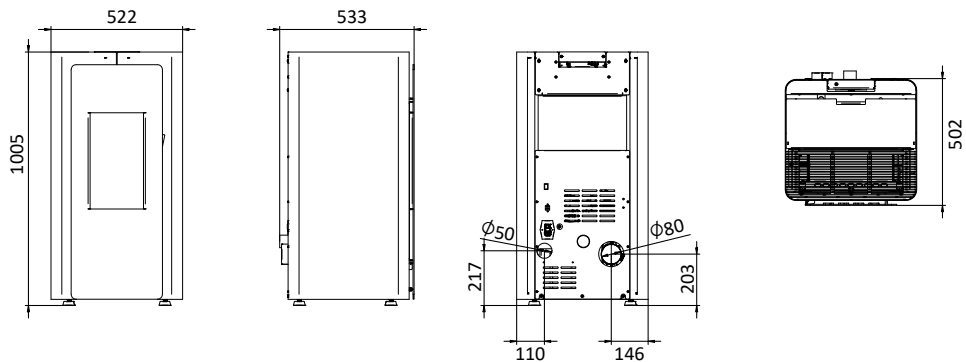

T401

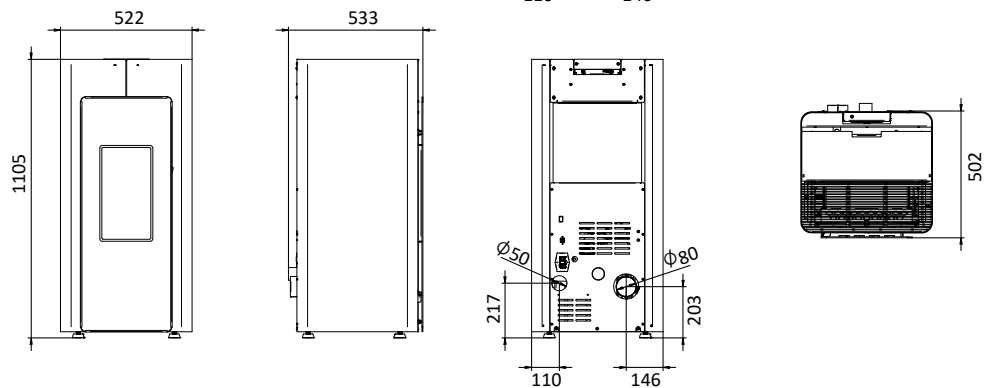

T601

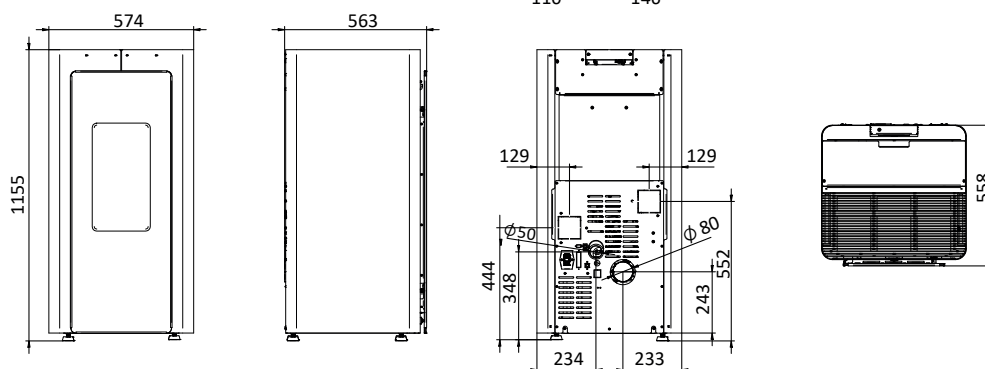

TUBE AIRTIGHT

SALAMANDRAS PELLETS Estufas de Pellets / Poêles à granulés / Pellet Stoves / Stufe a Pellet

T500
AIRTIGHT

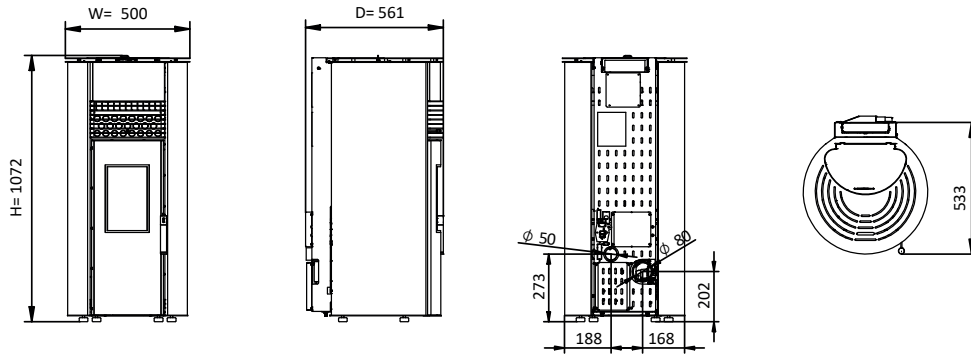



FOGO MONTANHA

WWW.FOGO-MONTANHA.COM



40 YEARS

Fogo Montanha
Rua dos Outarelos
3750-362 Belazaima do Chão
Águeda • Portugal
Tel. +351 234 650 650
info@fogo-montanha.com



WWW.FOGO-MONTANHA.COM

Cofinanciado por:

**COMPETE
2020**

**PORTUGAL
2020**



UNIÃO EUROPEIA
Fundo Europeu
de Desenvolvimento Regional